

## Winch type F 20 GP2

### Products

A range of standard pneumatic winches with high efficiency gearbox, developed for heavy duty pulling and lifting duties up to 2,700 kg. This broad range comprises a variation of very compact winches with vane or gear motors. Drum lengths can easily be adapted to the customers request.

Manufacturer code	F 20 GP2
Medium	Pneumatic
Environment	Oil and Gas
Application	Traversing
Series	F
Working Load Limit (WLL) [kg]	500 kg
Number of layers	5
Lifting WLL first layer	500 kg
Lifting WLL top layer	345 kg
Speed at first layer	25 m/min
Speed top layer	38 m/min
Drum capacity first layer	12 m
Drum capacity top layer	80 m
Rope diameter	6 mm
Mass	65 kg
Flow	65 L/sec
Pressure drop	7 bar

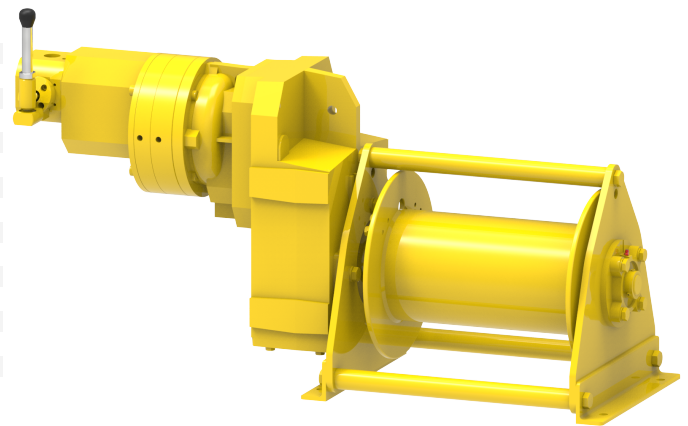

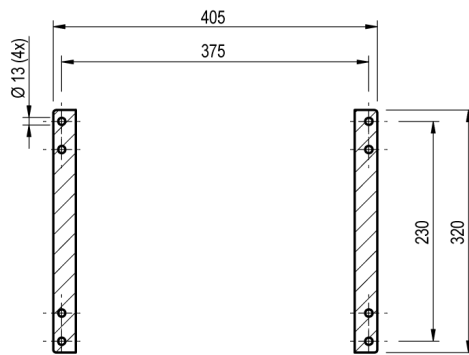
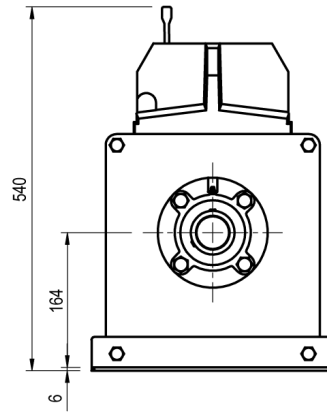
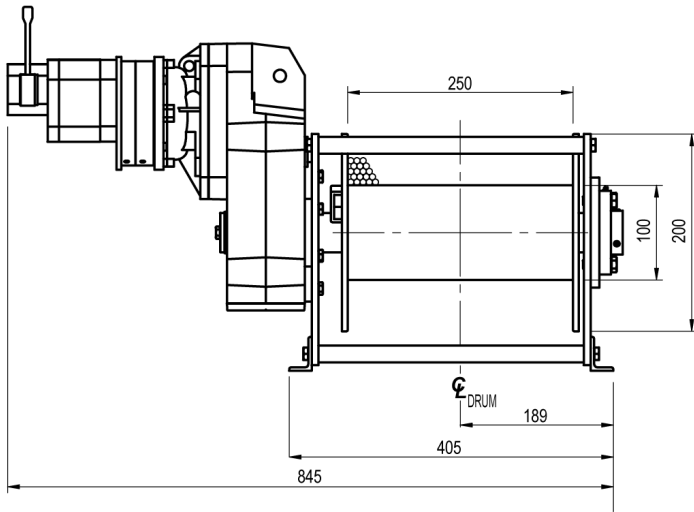

FOOTPRINT TOP VIEW

