

Winch type SB 300 GP4

Products

The standard build SB type winch provides the basis of the solution to many pulling and lifting winch applications. The winch is constructed in the conventional manner with motor, gearbox and drum in line. Capacities can go up to 70 tons of lifting capacity with this range. Although the name of this winch indicates differently, these winches are very suitable to suit your specific winch application. Many options can be offered on these highly versatile winches.

Manufacturer code	SB 300 GP4
Medium	Pneumatic
Environment	Oil and Gas
Application	Traversing
Series	SB
Working Load Limit (WLL) [kg]	1200 kg
Number of layers	5
Lifting WLL first layer	1200 kg
Lifting WLL top layer	845 kg
Speed at first layer	18 m/min
Speed top layer	23 m/min
Drum capacity first layer	26 m
Drum capacity top layer	168 m
Rope diameter	10 mm
Mass	260 kg
Flow	100 L/sec
Pressure drop	7 bar

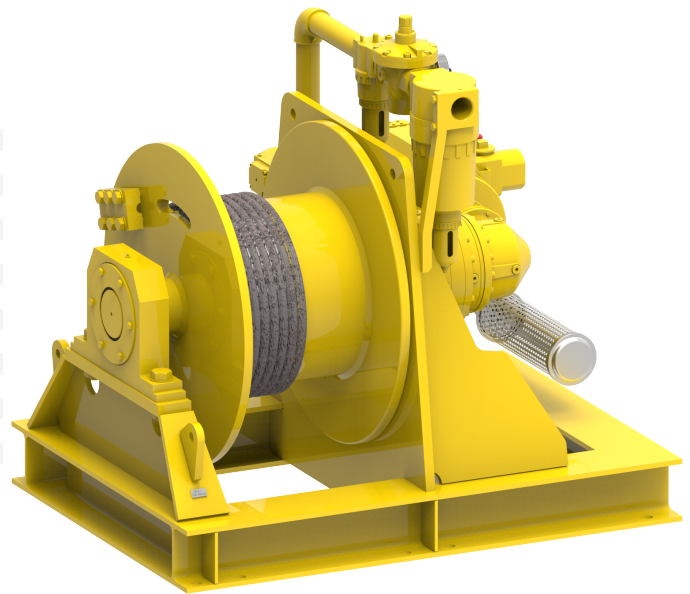

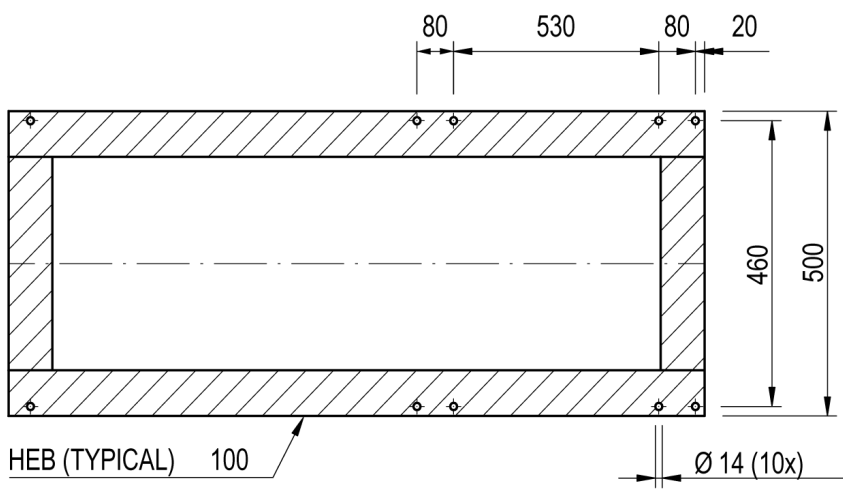
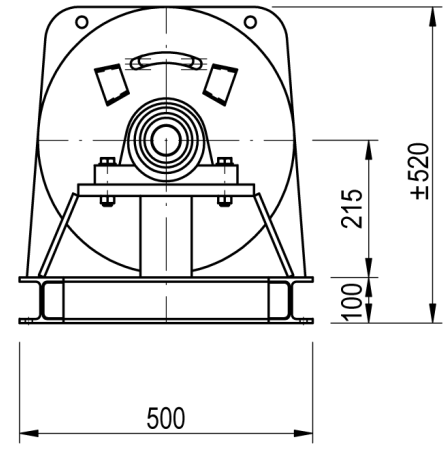
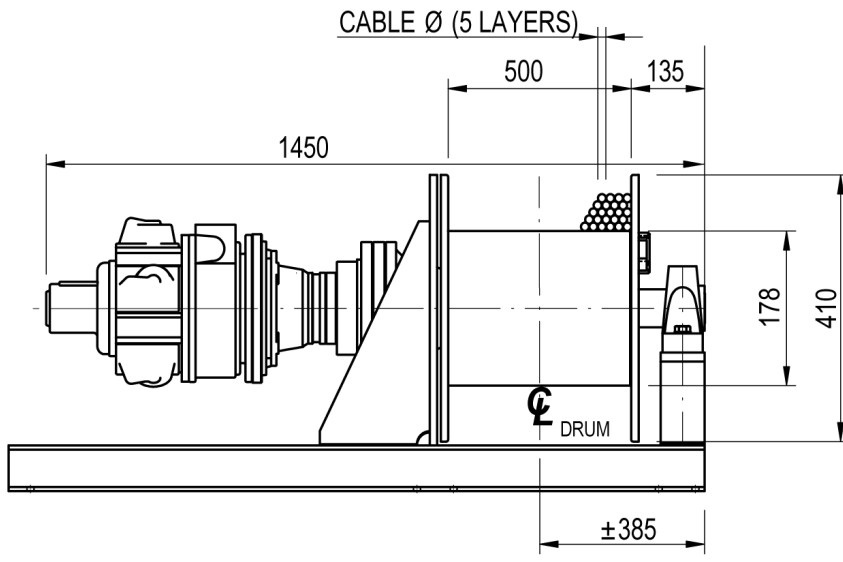

FOOTPRINT TOPVIEW