

Winch type SB 301 GP4

Products

The standard build SB type winch provides the basis of the solution to many pulling and lifting winch applications. The winch is constructed in the conventional manner with motor, gearbox and drum in line. Capacities can go up to 70 tons of lifting capacity with this range. Although the name of this winch indicates differently, these winches are very suitable to suit your specific winch application. Many options can be offered on these highly versatile winches.

Manufacturer code	SB 301 GP4
Medium	Pneumatic
Environment	Oil and Gas
Application	Traversing
Series	SB
Working Load Limit (WLL) [kg]	2100 kg
Number of layers	5
Lifting WLL first layer	2100 kg
Lifting WLL top layer	1435 kg
Speed at first layer	10 m/min
Speed top layer	15 m/min
Drum capacity first layer	24 m
Drum capacity top layer	157 m
Rope diameter	12 mm
Mass	270 kg
Flow	100 L/sec
Pressure drop	7 bar

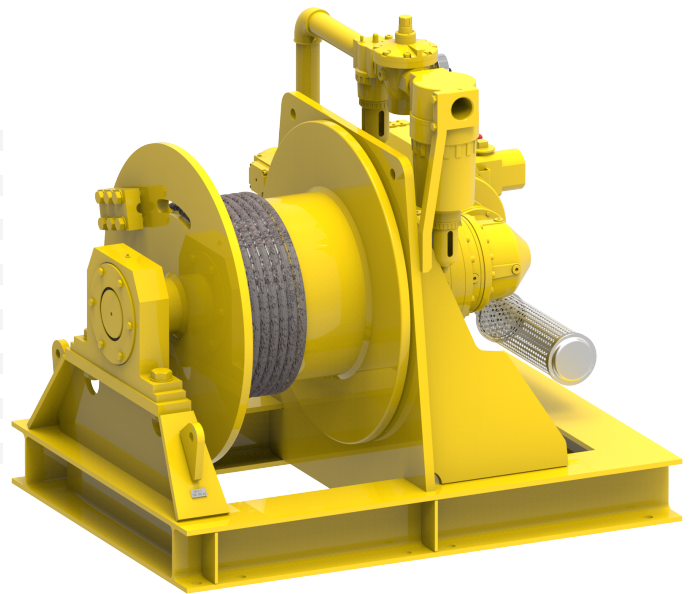

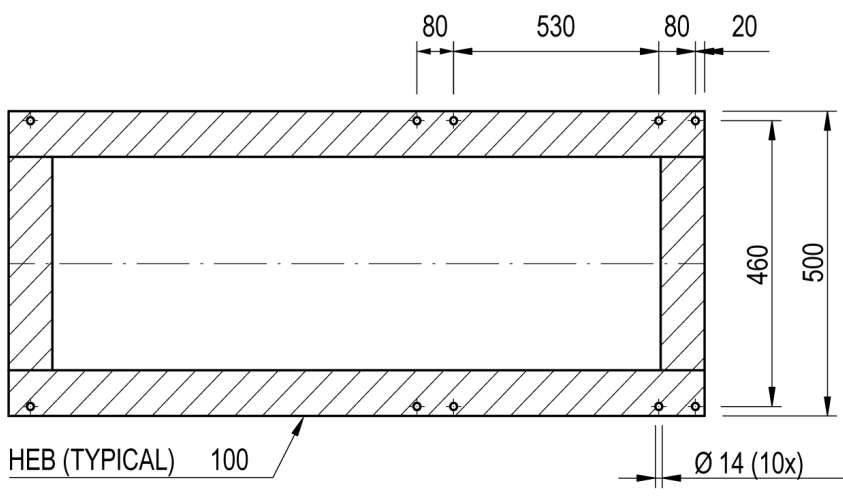
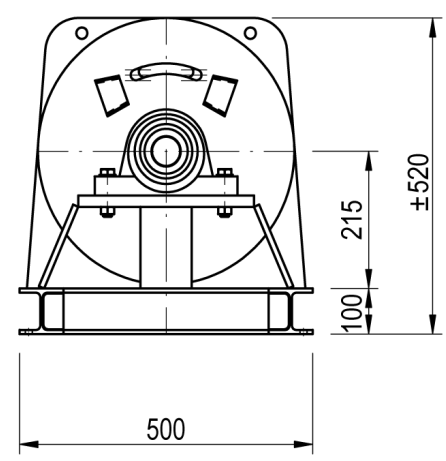
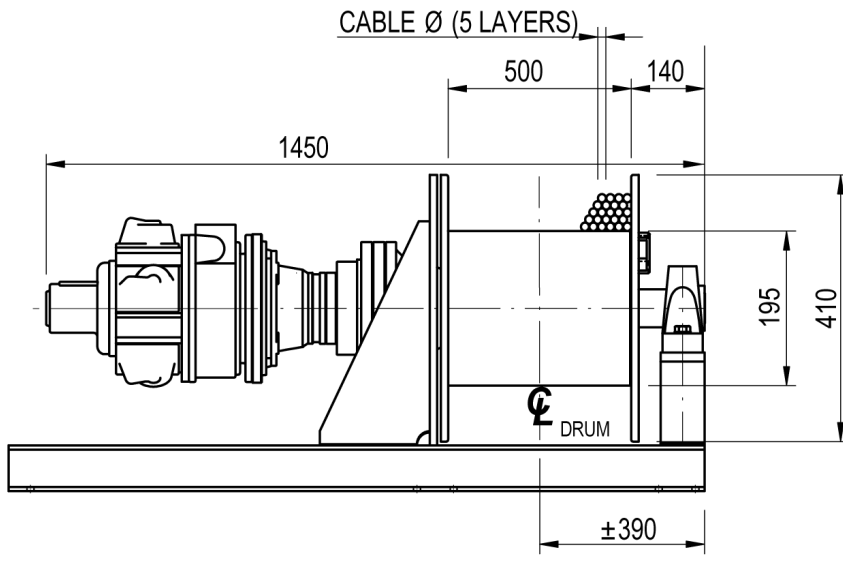

FOOTPRINT TOPVIEW