

## Winch type SB 303 LPR2

### Products

The standard build SB type winch provides the basis of the solution to many pulling and lifting winch applications. The winch is constructed in the conventional manner with motor, gearbox and drum in line. Capacities can go up to 70 tons of lifting capacity with this range. Although the name of this winch indicates differently, these winches are very suitable to suit your specific winch application. Many options can be offered on these highly versatile winches.

Manufacturer code	SB 303 LPR2
Medium	Pneumatic
Environment	Oil and Gas
Application	Traversing
Series	SB
Working Load Limit (WLL) [kg]	2500 kg
Number of layers	5
Lifting WLL first layer	2500 kg
Lifting WLL top layer	1740 kg
Speed at first layer	7 m/min
Speed top layer	10 m/min
Drum capacity first layer	26 m
Drum capacity top layer	165 m
Rope diameter	14 mm
Mass	390 kg
Flow	90 L/sec
Pressure drop	7 bar

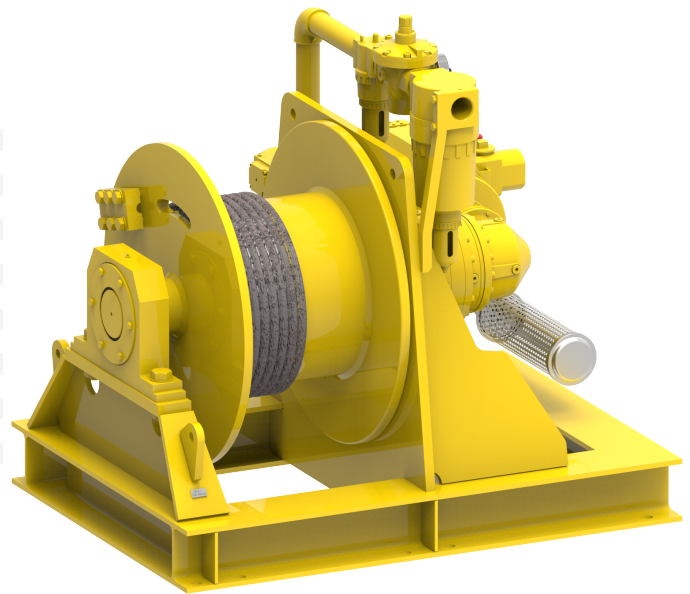

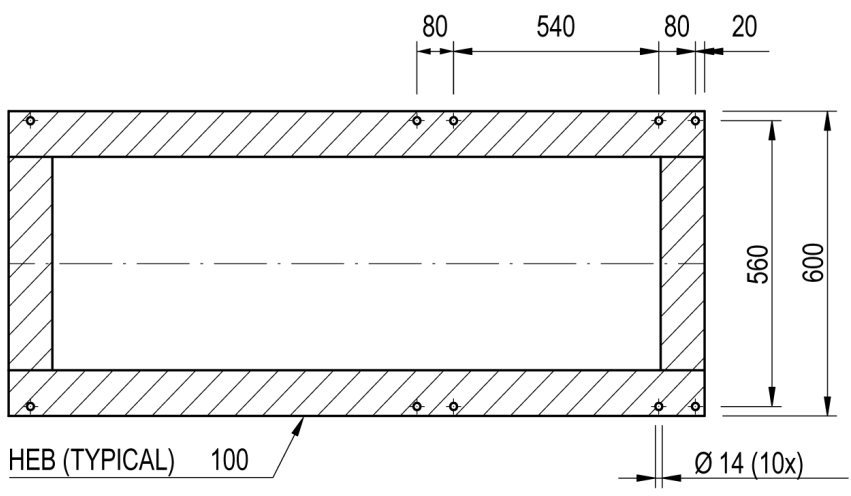
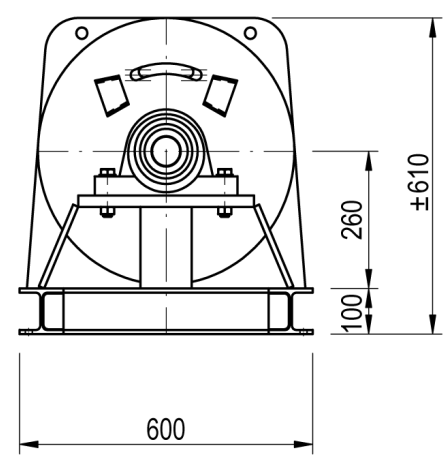
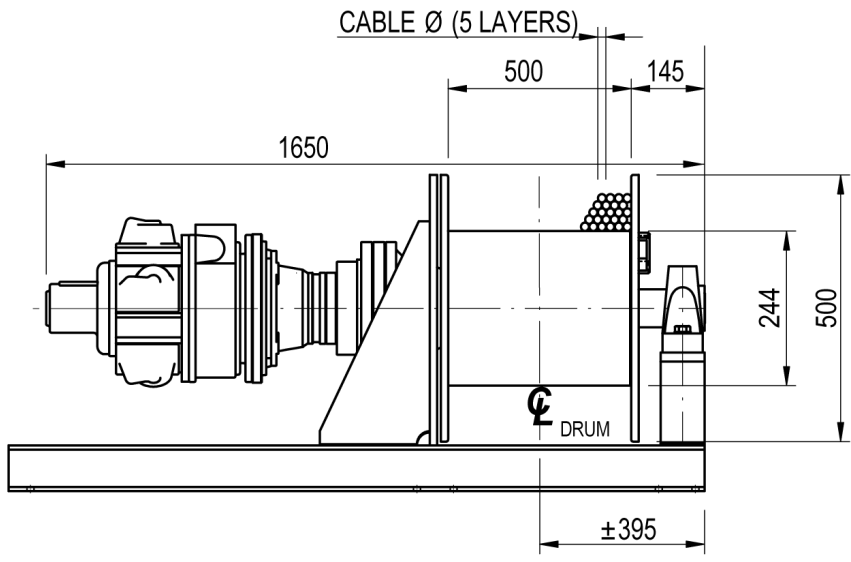

FOOTPRINT TOPVIEW