

Winch type SB 310 GP16

Products

The standard build SB type winch provides the basis of the solution to many pulling and lifting winch applications. The winch is constructed in the conventional manner with motor, gearbox and drum in line. Capacities can go up to 70 tons of lifting capacity with this range. Although the name of this winch indicates differently, these winches are very suitable to suit your specific winch application. Many options can be offered on these highly versatile winches.

Manufacturer code	SB 310 GP16
Medium	Pneumatic
Environment	Oil and Gas
Application	Traversing
Series	SB
Working Load Limit (WLL) [kg]	12000 kg
Number of layers	5
Lifting WLL first layer	12000 kg
Lifting WLL top layer	8460 kg
Speed at first layer	8 m/min
Speed top layer	20 m/min
Drum capacity first layer	24 m
Drum capacity top layer	168 m
Rope diameter	28 mm
Mass	1470 kg
Flow	350 L/sec
Pressure drop	7 bar

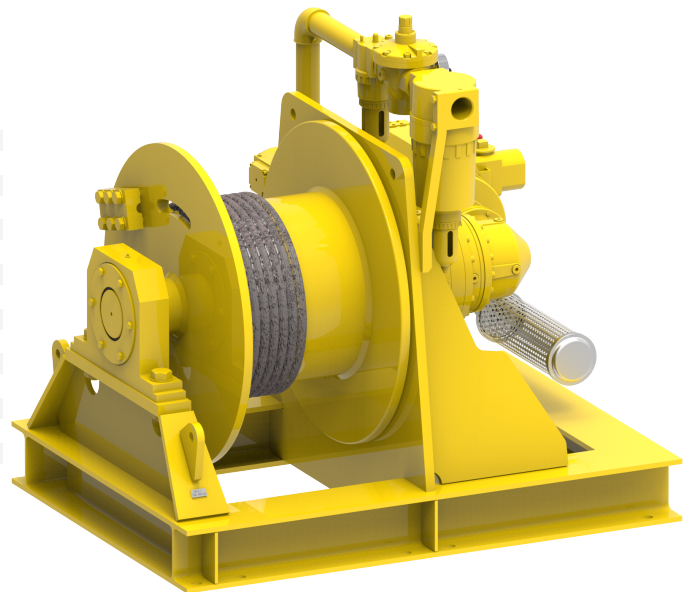

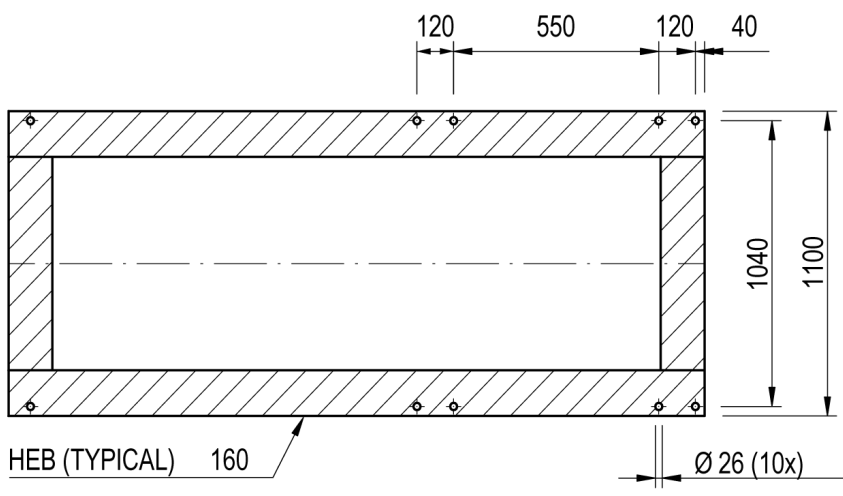
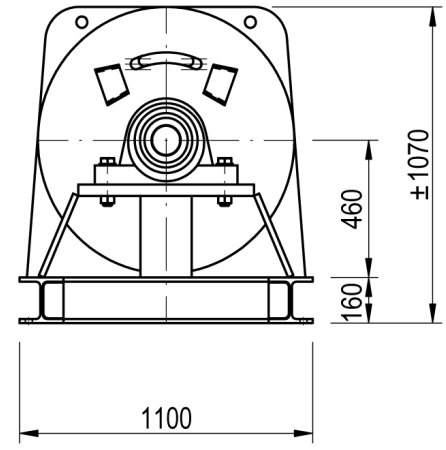
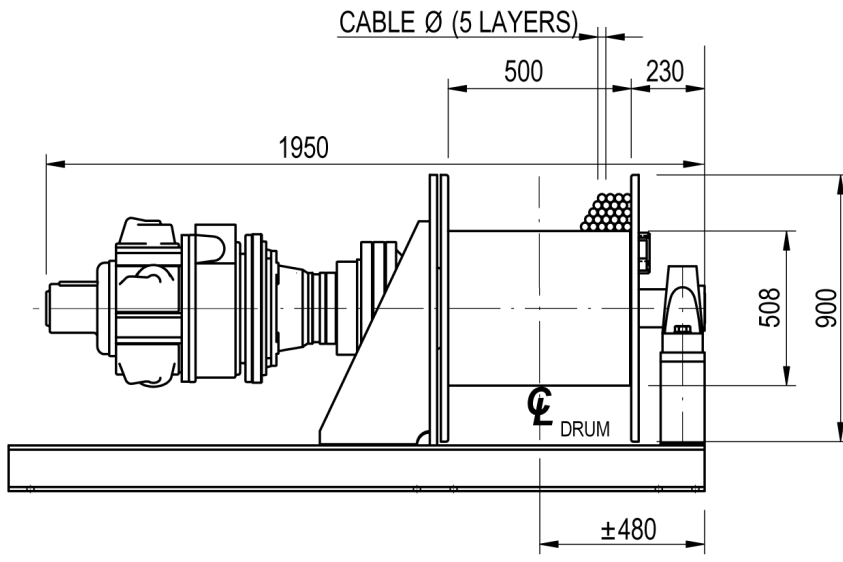

FOOTPRINT TOPVIEW