

Winch type SC 15 E

Products

A range of compact lifting and pulling winches utilising electric or hydraulic motors. The heavy duty planetary gearbox is located within the drum core, which both saves space and protects the gearbox from any external mechanical threats. Capacities can go up to 30 tons of lifting capacity with this range. Depending on your power source and application, we can select and offer the correct model for you.

| | |
|-------------------------------|-----------------|
| Manufacturer code | SC 15 E |
| Medium | Electric |
| Environment | Renewables |
| Application | Pulling |
| Series | SC |
| Working Load Limit (WLL) [kg] | 1955 kg |
| Number of layers | 5 |
| Lifting WLL first layer | 1955 kg |
| Lifting WLL top layer | 1500 kg |
| Speed at first layer | 8 m/min |
| Speed top layer | 10 m/min |
| Drum capacity top layer | 178 m |
| Rope diameter | 12 mm |
| Motor power S2 duty | 3 kW |
| Motor voltage | 400V-AC-3-phase |
| Mass | 315 kg |

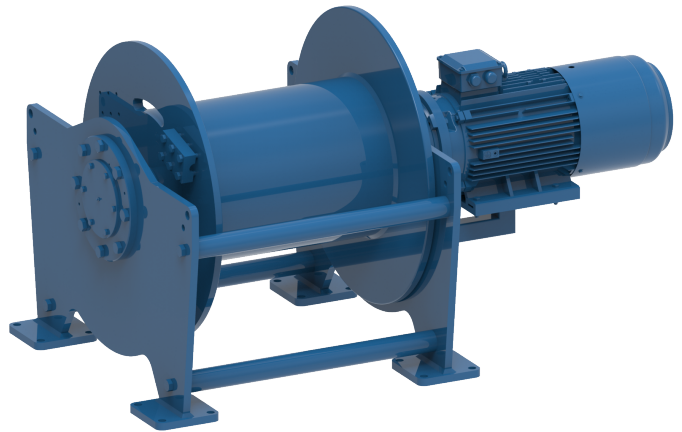

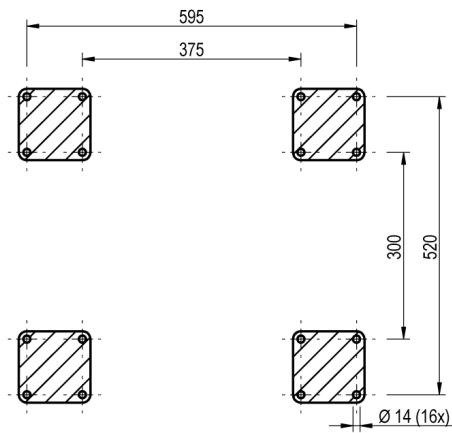
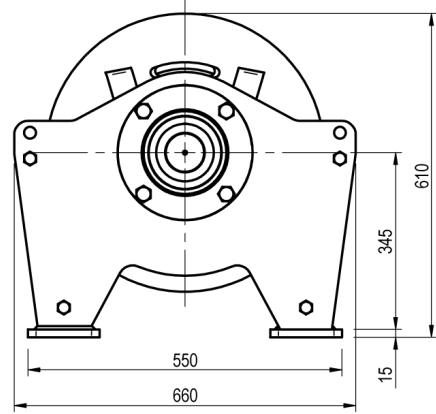
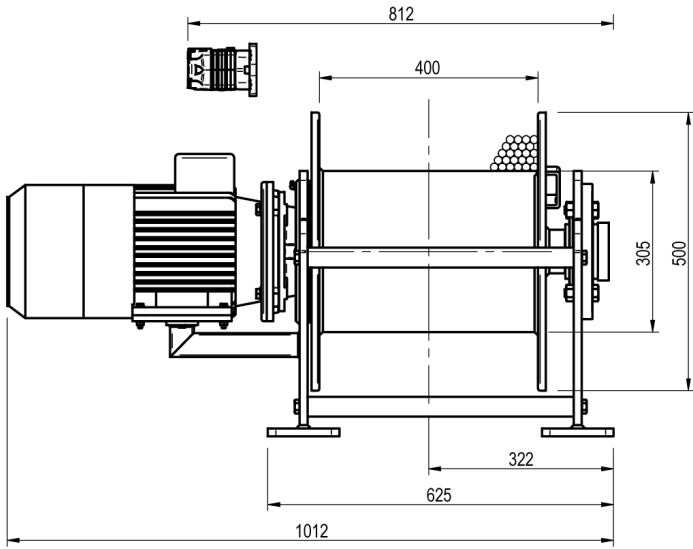

FOOTPRINT TOPVIEW A - A

