

Winch type SC 67 E

Products

A range of compact lifting and pulling winches utilising electric or hydraulic motors. The heavy duty planetary gearbox is located within the drum core, which both saves space and protects the gearbox from any external mechanical threats. Capacities can go up to 30 tons of lifting capacity with this range. Depending on your power source and application, we can select and offer the correct model for you.

Manufacturer code	SC 67 E
Medium	Electric
Environment	Renewables
Application	Pulling
Series	SC
Working Load Limit (WLL) [kg]	9700 kg
Number of layers	5
Lifting WLL first layer	9700 kg
Lifting WLL top layer	6700 kg
Speed at first layer	12 m/min
Speed top layer	17 m/min
Drum capacity top layer	195 m
Rope diameter	24 mm
Motor power S2 duty	22 kW
Motor voltage	400V-AC-3-phase
Mass	1120 kg

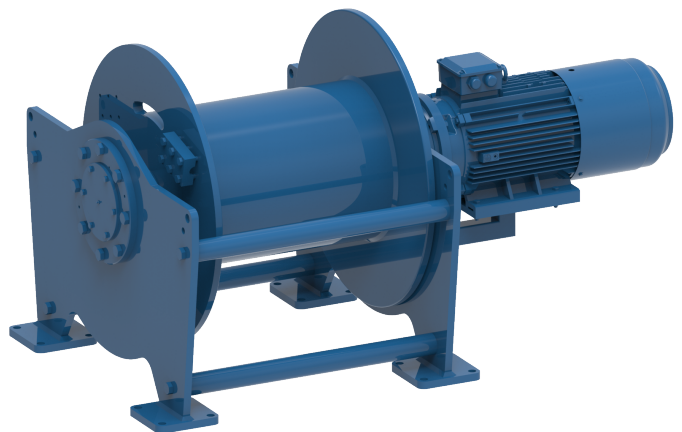

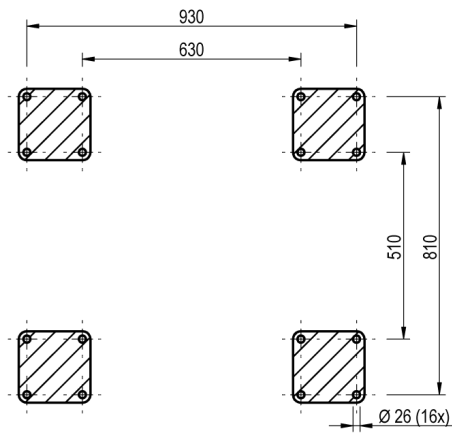
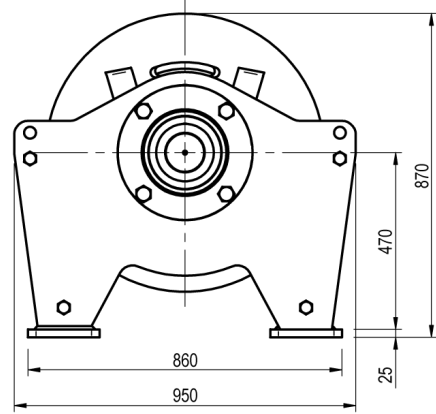
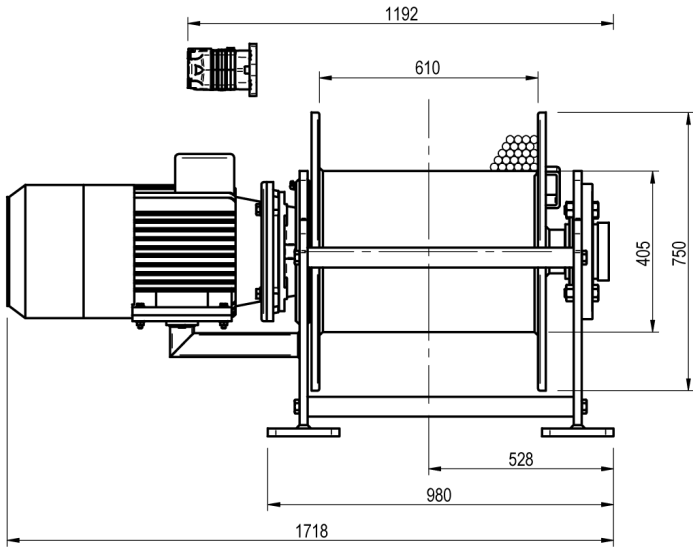

FOOTPRINT TOPVIEW A - A

